

ELLIOTT

9000

Volume 1: FUNCTIONAL SPECIFICATION
Part 3: OPTIONAL UNITS
Section 3: 4100 INTERFACE MATCHING UNIT

CONTENTS

	Page
Chapter 1: INTRODUCTION	
1.1 General Description	1
1.2 Connection to a 900 System	2
Chapter 2: TRANSFER OF DATA	
2.1 Introduction	3
2.2 Instructions	3
2.3 Matching Unit Status Word	4
2.4 Interface Lines	6
2.5 Timing	6
Chapter 3: PHYSICAL FEATURES AND REQUIREMENTS	
3.1 Introduction	7
3.2 Weight and Dimensions	7
3.3 Environmental Conditions	7
3.4 Power Supplies	7
Appendix 1. 4100 PERIPHERALS USED	

IN-TEXT FIGURES

Figure	Page
A TRANSFER OF DATA	1

Printed in England by
Engineering Unit, Elliott-Automation Computers Limited.

Chapter 1: INTRODUCTION

1.1 General Description

The 4100 Interface Matching Unit enables peripheral equipment which has been designed for the 4100 system to be used with the 900 system. The basic matching unit is provided with only two channels, but by the addition of extra logic boards, the number of channels may be increased, in steps of two, up to a maximum of eight. Thus, up to eight 4100 peripherals may be connected to the matching unit (by means of eight standard 4100 interface sockets) and the associated channels are numbered from 1 to 8.

Instructions from the 900 enable the matching unit to transfer data between the 900 computer and any one of the eight 4100 peripherals (see Fig. A).

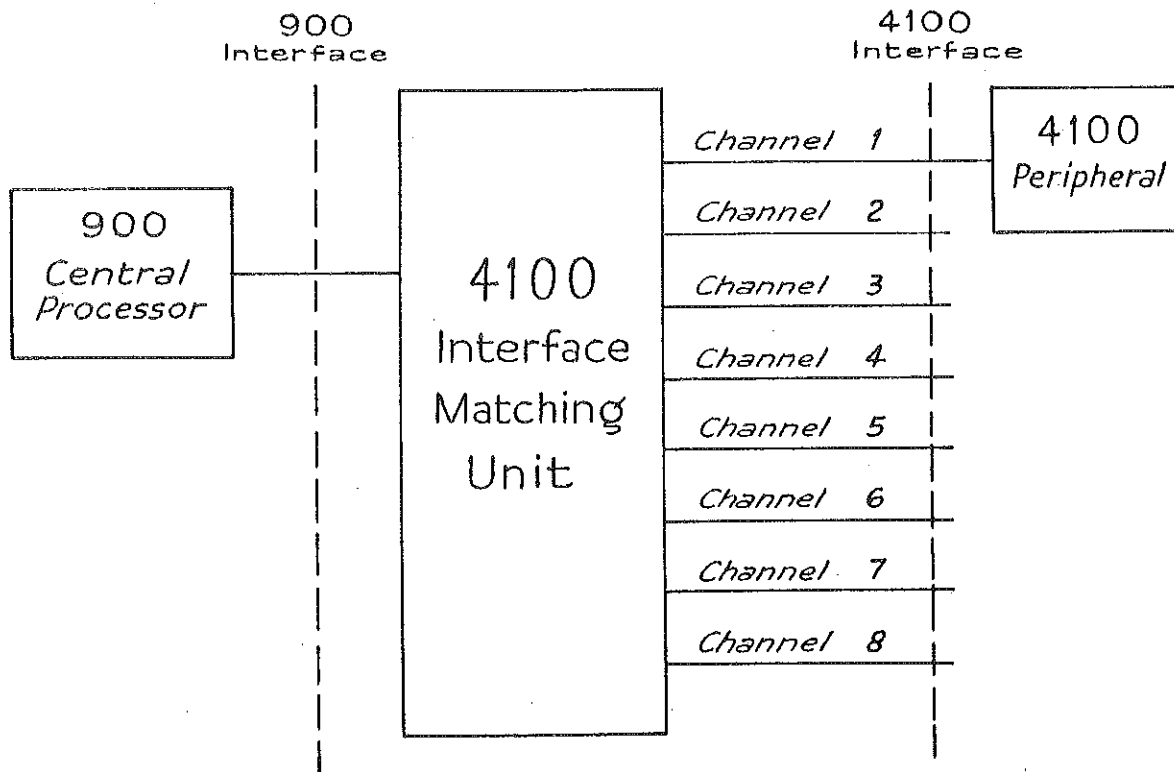

Fig. A TRANSFER OF DATA

1.2 Connection to a 900 System

1.2.1 The logic and associated power supplies are housed in one half of a standard 900 desk, the dimensions of which are given in Chapter 3.

1.2.2 The Matching Unit may be connected directly to the peripheral socket of the 900 computer or indirectly, via a multiplexer.

The maximum cable length from the Matching Unit to the 900 computer or multiplexer is 25ft., for which the standard 900 peripheral interface cableforms are used.

1.2.3 The maximum cable length from the Matching Unit to a 4100 peripheral is 25 ft., for which the standard 4100 peripheral interface cable is used.

1.2.4 The Matching Unit requires its own mains supply, to which it is connected by a flying lead of any suitable length, using a 13amp plug.

Chapter 2: TRANSFER OF DATA

2.1 Introduction

Information output from the 900 computer is stored in an 18-bit buffer register in the Matching Unit, then transmitted to the 4100 peripheral in the form specified by the 900 instruction. For a single or unpacked repetitive transfer instruction, the Matching Unit transmits the 8 least significant bits of the 900 word on the 8 DATA OUT lines to the 4100 peripheral, ignoring bits 9 to 18. For a packed repetitive transfer, the Matching Unit sends the 18 bits of the 900 word as a succession of three 6-bit characters on the least significant 6 DATA OUT lines to the 4100 peripheral.

On input, for a single or unpacked repetitive transfer, each 8-bit character from the 4100 peripheral is input as bits 1 to 8 of a 900 word, bits 9 to 18 of the word being zero. For a packed repetitive transfer, three 6-bit characters from the 4100 peripheral are assembled into the 18-bit Matching Unit buffer, for transfer as a word to the 900.

For control instructions to the 4100 peripheral, the significance of bits in the status and control characters is the same as that for the peripheral used on a 4100 computer.

2.2 Instructions

2.2.1 Single Transfer Instructions

A single 8-bit character is transferred between the selected peripheral and the 8 least significant bits of the 900 accumulator. Transfer may be either input or output of data or control characters, as shown below:

15 1536 + n, Input Data
15 1568 + n, Input Status
15 5632 + n, Output Data
15 5664 + n, Output Control

n represents the number of the channel selected.

2. 2. 2 Block Transfer Instructions

Data which is transferred due to block transfer instructions may be in the form of unpacked 8-bit characters or packed 6-bit characters. In the latter case each word comprises three 6-bit characters, which are transferred in the order bits 18 to 13, bits 12 to 7 and bits 6 to 1, for input and output.

The instructions used to transfer data between the selected peripheral device and the store are given below:

14 3648 + n, Input Data Packed Repetitive
 14 3584 + n, Input Data Unpacked Repetitive
 14 3680 + n, Input Status Packed Repetitive
 14 3616 + n, Input Status Unpacked Repetitive

 14 5696 + n, Output Data Packed Repetitive
 14 5632 + n, Output Data Unpacked Repetitive
 14 5728 + n, Output Control Packed Repetitive
 14 5664 + n, Output Control Unpacked Repetitive

n represents the number of the channel selected.

It should be noted that whilst channel numbers are in the range 1 to 8, the corresponding values of n are in the range 0 to 7. Thus channel 1 is specified by n = 0, channel 2 by n = 1, etc.

2. 3 Matching Unit Status Word

There is a status word used with the 4100 Interface Matching Unit. The instruction 15 1600 (Input Status Word) causes the status word to be read in to the accumulator. The significant bits of this word are used to indicate the following:

Bit No.	Significance		
* n+1	INTERRUPT line on channel n true	-	'0'
	INTERRUPT line on channel n false	-	'1'
* n+9	ATTENTION line on channel n true	-	'0'
	ATTENTION line on channel n false	-	'1'
17	VALID line false at any time during data transfer for the selected channel	-	'1'
	VALID line true during data transfer	-	'0'
18	COMPLETE signal detected before the transfer of the last character in Block Transfer instruction; or VALID line false for selected channel	-	'1'
	COMPLETE signal not detected during data transfer; VALID line true for selected channel	-	'0'

* n represents the number of the channel selected.

NOTE: Bits 17 and 18 of the status word are set to their appropriate values by each single or block transfer instruction. They will each be set to a '1' if a non-existent 4100 peripheral is addressed and if an input data or input status instruction occurs, any characters which are transferred from the matching unit to the 900 central processor are undefined. If VALID becomes false or COMPLETE becomes true, dummy transfers are performed and the status word indications are set.

Bit 18 is also set to a '1', during a packed block transfer instruction, if the 4100 peripheral device can only transfer a fixed number of characters, the total number of which is not a multiple of three (for example 80 or 128). In an input data or input status instruction, characters transferred after the COMPLETE signal is detected, are undefined.

2.4 Interface Lines

2.4.1 INTERRUPT and ATTENTION

The INTERRUPT and ATTENTION lines for all eight channels of the standard interface matching unit are routed to the LEVEL 2 INTERRUPT line.

2.4.2 RESET

When RESET becomes true, bits 17 and 18 of the status word are reset to zero, all operations are immediately terminated, and the bistables in the logic are set to their correct initial states. A 16ms. RESET pulse is sent to all 4100 peripherals.

2.4.3 VALID and COMPLETE

These two 4100 signals, having no 900 equivalent, are not transmitted across the latter interface. The only indication of the state of these lines is given by the Matching Unit status word.

2.5 Timing

The calculated maximum character transfer rate on the 903 for repetitive input and repetitive output instructions is approximately 200,000 characters/sec. for a 4100 peripheral with response time of $2\mu\text{s}$. or less.

The maximum delay between the response of a peripheral and the matching unit replying to the 900 is $1.2\mu\text{s}$.

The maximum delay between addressing the matching unit and sending REQUEST to a peripheral, from the matching unit, is $3\mu\text{s}$.

Chapter 3: PHYSICAL FEATURES AND REQUIREMENTS

3.1 Introduction

Physical details, environmental conditions and power supplies for the 4100 Interface Matching Unit are given in this Chapter.

3.2 Weight and Dimensions

The Matching Unit, complete with power supplies, occupies half a standard 900 desk. The weight of the Matching Unit and dimensions of the standard desk are given below:

Height		Width		Depth		Weight	
cm	in	cm	in	cm	in	kg	lb
94	37	109.2	43	66	26	40	90

Clearances required for maintenance: 2ft. 6in. to the front and rear of the desk.

3.3 Environmental Conditions

The 4100 Interface Matching Unit has been designed to be used in a normal office environment where the following conditions are assumed to apply:

Temperature 10°C to 30°C (50°F to 86°F)

Relative Humidity 20% to 95% without condensation.

No specific dust control other than reasonable standards of cleanliness.

Under these conditions, external environmental control is not normally required.

3.4 Power Supplies

The equipment operates from a mains power supply of $230\text{V} \pm 10\%$ at $50\text{ c/s} \pm 2\%$

Peak power consumption : 25VA.

Average power consumption : 20VA.

Average heat dissipation : 80 B. Th. U. /Hr.

APPENDIX 1. 4100 Peripherals Used

The following 4100 peripherals have so far been tested on a 903 through the Matching Unit:

Buffered lineprinter, 300 l. p. m.

Card reader

Paper tape station

Multiple teleprinter controller